

ITEMS: #56985  
DOUBLE DRAWER

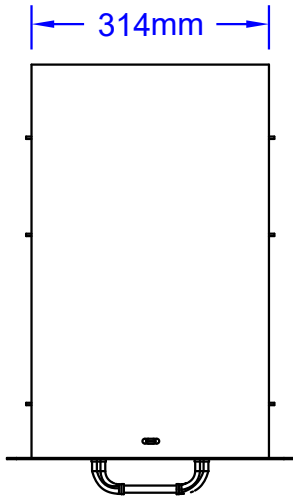

Top View

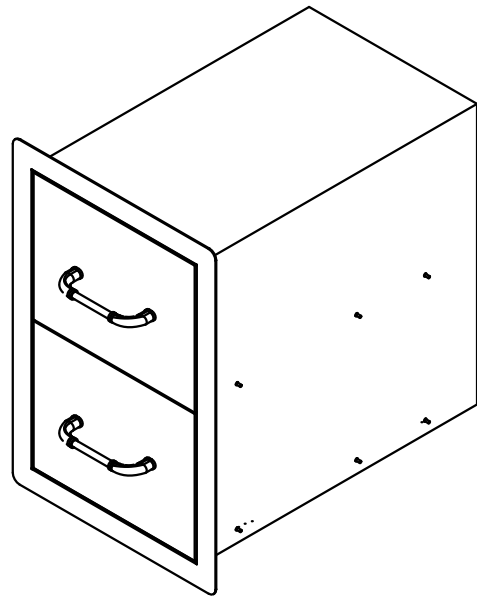

Isometric View

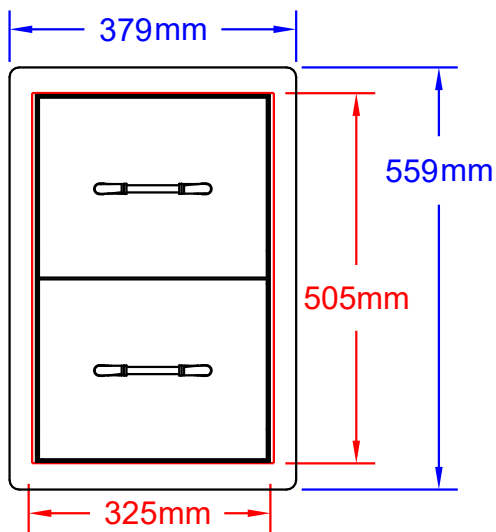

Front View

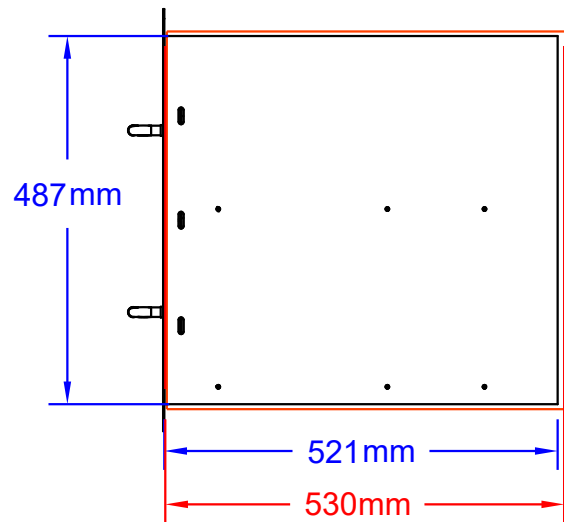

Side View

SPEC SHEET NOTES:

1. CUT DIMENSION 325L X 530D X 505H
2. SCALE: 1 : 10( Printer page scaling none, do not use fit to printable area option)
3. REVISION: 05/2020